



SilverNugget™ N2-MX

The SilverNugget N2-MX is a highly compact motion controller and driver for driving high pole count micro step NEMA, 11, 17, 23, and 24 frame motors. With the addition of a high-resolution differential encoder and a bipolar micro step motor, the SilverNugget N2-MX provides a high performance servo positioning and rotary system. The SilverNugget has two integrated cables for interfacing with the primary encoder as well as the micro step motor. Once connected, the QuickControl software will guide a user through the SilverNugget encoder alignment and configuration process.

SilverNugget N2-MX is specifically designed to drive 100 poles, 1.8° step motors. To best utilize the capabilities of the SilverNugget, select a motor that has been optimized for micro stepping.

Power, communications, and I/O are accessed through a single DB15 high density interface connector. The interface includes 7 I/O, all of which support both LVTTTL and analog signals, and one of which also supports 0 to 10v analog. A hardware drive enable is available as a factory option (Special order). All 7 I/O also have soft configurable pull-up/pull-down resistors, which may also be disabled, for more flexibility.

System Overview

Point-to-Point Moves

- Relative or Absolute
- Velocity or Time Based
- S-Curve

Advanced Motion Profile Moves

- Profile Move Commands
- Register Based
 - Position
 - Accel/Decel
 - Velocity
 - Modify On-the-Fly
 - Non-zero velocity start & stop

Input/Output

- 7 LVTTL Digital I/O
 - Bi-Directional
 - Set While In Motion
- 7 Analog Inputs (Joystick)
- 1 Analog 0-10v Input
- 1 Output supports PWM out
- 1 Input supports PWM in
- Programmable Logic Switch out
- Secondary Encoder In
- Encoder Out (single ended and differential)

Program and Data Storage

- 32K Non-Volatile Memory:
- 2000-3000 Program Lines
- User Data Examples
 - CAM Tables
 - Motion Profiles
 - Lookup Tables

Electronic Gearing/Camming

- Follow External Signals
 - Encoder (A/B Quadrature)
 - Step and Direction
- Gearing plus Trapezoid motion
- Electronic Cam
 - Import Cam Table from File
- Gearing with extended precision:
 - A/B gearing
 - xxx.xxxxxxxx multiplier (8 places behind decimal point)

Electronic Slip Clutch/Brake

- Variable Torque
- Wind/Unwind Applications
- Communications
- RS-485 (ASCII, Modbus®, DMX, 9-bit)
- Up To 230K Baud
- Host Control While Servo in Motion

Programming Language

- Easy, Menu Driven Interface
- Command Parameter Prompts
- No Syntax Error
- User Namable I/O and Registers

Advance PVIA™ Servo Loop

- Improvement Stability
- Simulated Viscous Inertial Damper
- 100:1 Inertial Mismatch
- Direct Drive Oversized Inertial Loads
 - Flywheels
 - Belt Drives
 - Typically eliminates need for Gearheads

Anti-Hunt™

- Optionally transition to open loop while in position – automatically changes back to full servo if position is disturbed.
- No Servo Dither While at Rest

Multi-Task/Multi-Thread

- Two programs plus a motion simultaneously
- Multiple background protection settings

Compatible with QCI's M-Grade Hybrid Servo Motors as well as 3rd party motor with encoders.

Electrical Specifications

Input Power

Voltage

+12.5 VDC to +48 VDC, regulated. Device must be initialized for the actual operating voltage. An external clamp may be required if rapid decelerations of large loads are present. Both V+ pins and both PGND pins shall be used. The power circuit shall be fused at no more than 8A if the power supply is capable of more than 8 Amps. PGND is also connected to the frame of the controller/motor.

Input Current

5.5 Amps maximum for any input voltage, +12.5 VDC to +48 VDC per controller.

Output Power

Output/Driver Current

5 Amps continuous per phase.

Maximum Output Power

200 Watts continuous power at nominal 25C ambient. May be derated at higher temperatures according to air flow.

Inputs & Outputs

Digital Inputs

0 to +3.3 VDC. LVTTTL level compatible. All inputs have a light pull-up (~100k ohm to 3.3v). All I/O have an optional programmable pull-up/pull-down of 2.2 k ohm; the source to these resistors may also be floated if no pull-up or pull-down is needed. The seven IO are protected to +/- 40v.

Digital Output Voltage

0 / +3.3 VDC.

Digital Output Current

Sinking or Sourcing: 2mA

External Encoder Inputs

Maximum Bandwidth: 5 million counts per second from a secondary encoder, quadrature decoding. (External encoder input filtering at minimum setting.)

Analog Inputs

All 7 I/O may be used as Analog Inputs: 0 to +3.3 VDC input signal range. IO7 has a secondary circuit to handle 0 to +10v input signal range; the input protection will isolate the normal 3.3 v input channel allowing the 0 to 10v operation. Resolution: 12 bits (before filtering), interpolated to 15 bits via filtering.

Analog signals are read every servo cycle (120 μ sec.) and the converted analog data is processed through a (default) 5 ms filter to reduce noise & transients, and to extend resolution.

Communications

Serial Interface

RS-485 multi-drop, Reduced unit load accommodates up to 254 nodes. Protected up to +/- 60v. Note: RS-485 requires a nominal 120 ohm $\frac{1}{2}$ W termination resistor at each end of the network for longer runs. This termination is not provided onboard and must be provided by the user. Simple termination is sufficient, biased termination is not needed with this device.

Protocols

8-bit ASCII, 9-bit binary, Modbus®, and DMX512

Hardware Configuration Settings

Available Baud Rates: 2400, 4800, 9600, 19.2k, 28.8k, 57.6k, 115.2k or 230.4k

(250k only for DMX512)

Data Bits: 8 (9 bits for binary)

Stop Bits: 1.5 or 2

Parity Bit: None (Modbus supports None, Even, Odd)

Servo Control Specifications

Primary Encoder Resolution

500 Lines = 2000 counts/revolution (minimum recommended resolution)

1000 Lines = 4000 counts/revolution

2000 Lines = 8000 counts/revolution

4000 Lines = 16000 counts/revolution

Primary Encoder Index or Z Channel

QCI highly recommends obtaining an encoder with an Index or Z channel for use with the SilverNugget N2-MX. The index allows the SilverNugget N2-MX to perform minor alignment corrections while in motion, and to synchronize with the optimal encoder phasing for the motor, as determined when the motor was unloaded during initialization. While the SilverNugget N2-MX will work without an index signal, complications can arise. For example, some encoder manufacturers use the same optical reader for encoders with and without an index. Therefore, the Z channel can potentially output a signal even though there isn't a true index. Contact QCI Support for further information on using an encoder without an index.

Primary Encoder Signal Type

Differential Encoder Signals

Maximum Rotational Speed

4000 Revolutions per Minute; limited in controller software.

Typical Bipolar Micro Step Motor Parameters

NEMA Size	Minimum Winding Insulation Rating	Typical Phase Current Rating	Phase Winding Resistance	Phase Winding Inductance	Motor Constant K_m (V/rad/sec)	Rotor Inertia (oz-in ²)
17 Frame	48 Volts	2 Amps to 5.1 Amps	0.5Ω to 2.1Ω	0.7mH to 3mH	0.06 to 0.19	0.19 to 0.37
23 Frame	48 Volts	3.5 Amps to 5 Amps	0.25Ω to 1.2Ω	0.54mH to 5.7mH	0.1 to 0.52	0.74 to 2.35

Servo Cycle Rate

120 microseconds → 8.33 kHz

Software Torque Control

Signed 16-bit control: 1 part in 32767

Internal Memory

Serial Communications Buffer Size: 10 words

Program Buffer Size: 1023 Words

Non-Volatile Memory Size:

32K bytes (16K words)

Status Lights

Two status lights are provided on the back of the SilverNugget. The COMM. LED (normally Red) indicates the unit is ready (no program running) by a dim level, it is off between communications if a program is running. It blinks brightly during each incoming communications frame. The Status light (normally Green) varies in intensity with the motor torque (negative torque dimmer, positive torque brighter); if Done Bit is configured the LED lights to indicate Done (See Set Done Bit command), is also used to blink error codes if a fault is detected (and the Done bit is not configured).

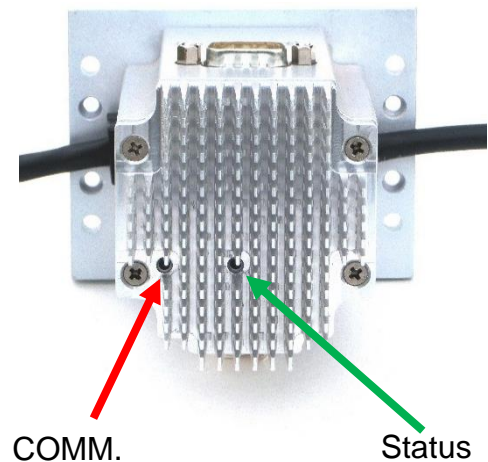

Environmental Specifications

Operational Temperature

-10 C to +70 C. Continuous torque curves taken at 20C; derating may be needed at higher temperatures.

Storage Temperature

- 40 C to +85 C

Humidity

Continuous specification is 95% RH non-condensing.

Shock

Limitation is approximately 50g/11ms

Wiring and Cable Specifications

Stepper Motor Wiring Configuration

Ideally, the SilverNugget will be interfaced with a four wire bipolar motor. Then the SilverNugget four wire motor cable will match up with the leads from the micro-step motor. Although, the SilverNugget will work with motors that have more than 4 wires.

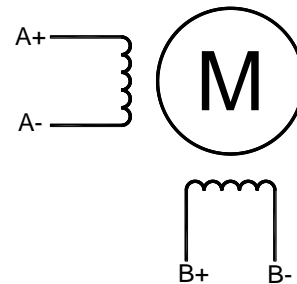

4 Wire Bipolar Configuration

Some bipolar micro step motors are manufactured with 8 wires. Typically, an eight wire motor is wired in a parallel configuration for use with the SilverNugget. However, a series wiring configuration is acceptable. Either configuration is perfectly legitimate to obtain the best motor characteristics and achieve optimum performance.

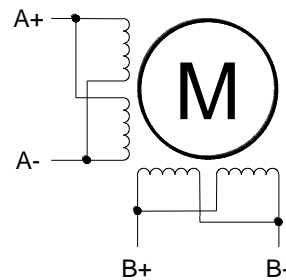

8 Wire Parallel Bipolar Configuration

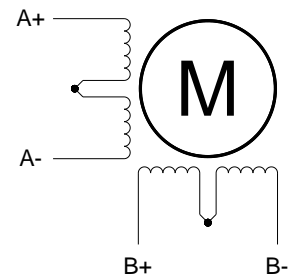

8 Wire Series Bipolar Configuration

Unipolar motors are not suggested with the SilverNugget, as they are typically higher inductance and higher resistance than equivalent bipolar configurations.

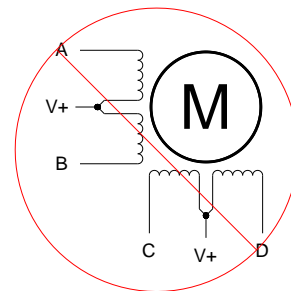

Unipolar Configuration

Encoder Feedback Connection: 8-Wire Encoder Cable

Designation	Wire Color	Wire Gauge
Encoder +5V	Red	26 AWG
Encoder Gnd	Black	26 AWG
Encoder A+	White	26 AWG
Encoder A-	Yellow	26 AWG
Encoder B+	Green	26 AWG
Encoder B-	Blue	26 AWG
Z+ (index +)	Orange	26 AWG
Z- (index -)	Brown	26 AWG

- For a back mounted encoder, the encoder’s A Channel should lead B Channel when the front motor shaft rotates clockwise.

Encoder Cable Specifications

Nominal Cable Diameter =	0.25 inches
Minimum Bend Radius =	1.8 inches
Each Wire Pair Has A Shield	
Shields Connected To SilverNugget Case	

Driver Winding Signals: 4-Wire Motor Cable

Designation	Wire Color	Wire Gauge
Winding A+	Red	20 AWG
Winding A-	Blue	20 AWG
Winding B+	Yellow	20 AWG
Winding B-	White	20 AWG
Drain †	Bare Wire	2x22 AWG ‡

Motor Cable Specifications

Nominal Cable Diameter =	0.24 inches
Minimum Bend Radius =	1.7 inches
Each Wire Pair Wrapped with Shield and 22 AWG Drain Wire	

† The Drain Wires and Shields, collectively called the Drain, are connected to the SilverNugget case. QCI recommends connecting the Drain to the micro step motor chassis.

‡ The Drain current rating is that of two 22 AWG wires in parallel.

SilverNugget Cable Connector Options

SilverNugget Part Number Cabling Interface Designation:

QCI-N2-MX-BB01

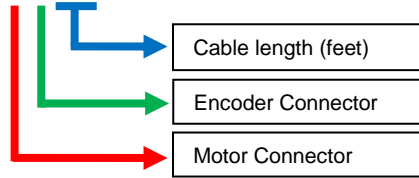

The first letter specifies the type of connector placed on the end of the motor cable. The second letter specifies the type of connector placed on the end of the encoder cable. Options for the motor and encoder cable are interchangeable. For example, ordering a SilverNugget, with the ABxx option, would mean the motor cable has flying leads and the encoder cable has a TE or Molex compatible connector.

Cable lengths are available from 1 foot to 25 feet in one foot increments. For longer lengths, contact QCI Support.

A – Cable has flying leads.

The AA option comes with flying leads on both the Motor and Encoder cables.

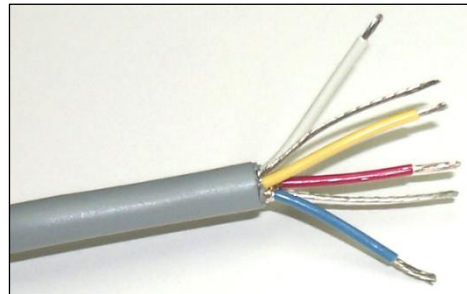

B –

Motor Cable: Standard 5-pin, Single Row, .093" Socket Connector

- TE or Molex compatible connector, with crimped pins, attached to end of cable.

Encoder Cable: Standard 10-pin, Dual Row, .1" Socket Connector

- Molex compatible connector, with crimped pins, attached to end of cable.

The BB option (standard SilverNugget N2-MX option) comes with a TE or Molex compatible connector on the motor cable and Molex compatible connector on the encoder cable.

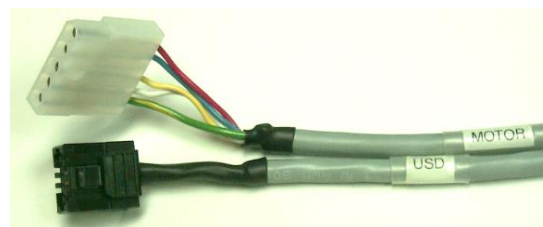

B Option on Motor Cable

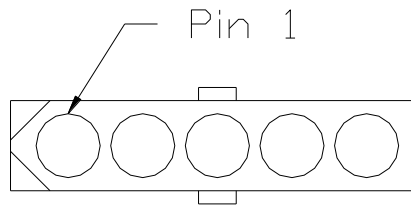

Motor Cable Connector Face View.

Motor Cable Connector Pinout		
Pin Number	Signal	Wire Color
1	Winding A+	Red
2	Winding A-	Blue
3	Winding B+	Yellow
4	Winding B-	White
5	Chassis Gnd	Grn/Ylw

Motor Cable Connector Part Numbers

Description	TE Connectivity Part #	Molex Part #	Total Used
Housing	770083-1	03-09-1054	1
Female Pins	770146-1	02-09-1119	5

Mating Cable Connector Part Numbers

Description	TE Connectivity Part #	Molex Part #	Total Used
Housing	770084-1	03-09-2057	1
Female Pins	770147-1	02-09-2118	5

B Option on Encoder Cable

The B option for the encoder cable interfaces with a US Digital 10 pin, dual row differential encoder connector.

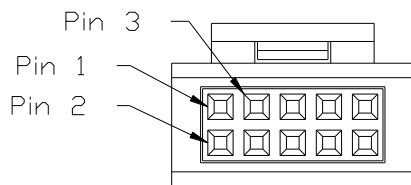

Encoder Cable Connector Face View

Encoder Cable Connector Pinout

Pin Number	Signal	Wire Color
1	Not Used	
2	Encoder Gnd	Black
3	Z- (Index -)	Brown
4	Z+ (Index +)	Orange
5	Encoder A-	Yellow
6	Encoder A+	White
7	Encoder +5V	Red
8	Not Used	
9	Encoder B-	Blue
10	Encoder B+	Green

Encoder Cable Connector Part Numbers

Description	Molex Part #	Total Used
Housing	15-04-5104	1
Insert	22-55-2103	1
Female Pins	16-02-0104	8

Mating Encoder Cable Connector Part Numbers

Description	Molex Part #	Total Used
Housing	50-65-0010	1
Insert	22-55-2103	1
Female Pins	16-02-0117	8

Note: SilverNugget N2-MX replaces QCI's standard DSUB 15-pin high density motor connector with 10-pin Encoder and 5-pin Motor connectors. Since, the motor memory signal is not brought out, the SilverNugget N2-MX is not capable of reading motor memory on QCI's I-Grade motors.

Connector Data

SilverLode Multi-Function Interface (SMI) Port (P1)

The SMI port is a DB15HD (pin) connector containing input power, I/O and communications. The Basic Breakout 1 (QCI-BO-B4) attaches directly to the SMI port (no cable) and provides access to all interface signals. Alternately, an SMI cable (QCI-C-EC-SMI-nn, nn=length) can be used to interface with the optical I/O module, QCI-OPTMC-24.

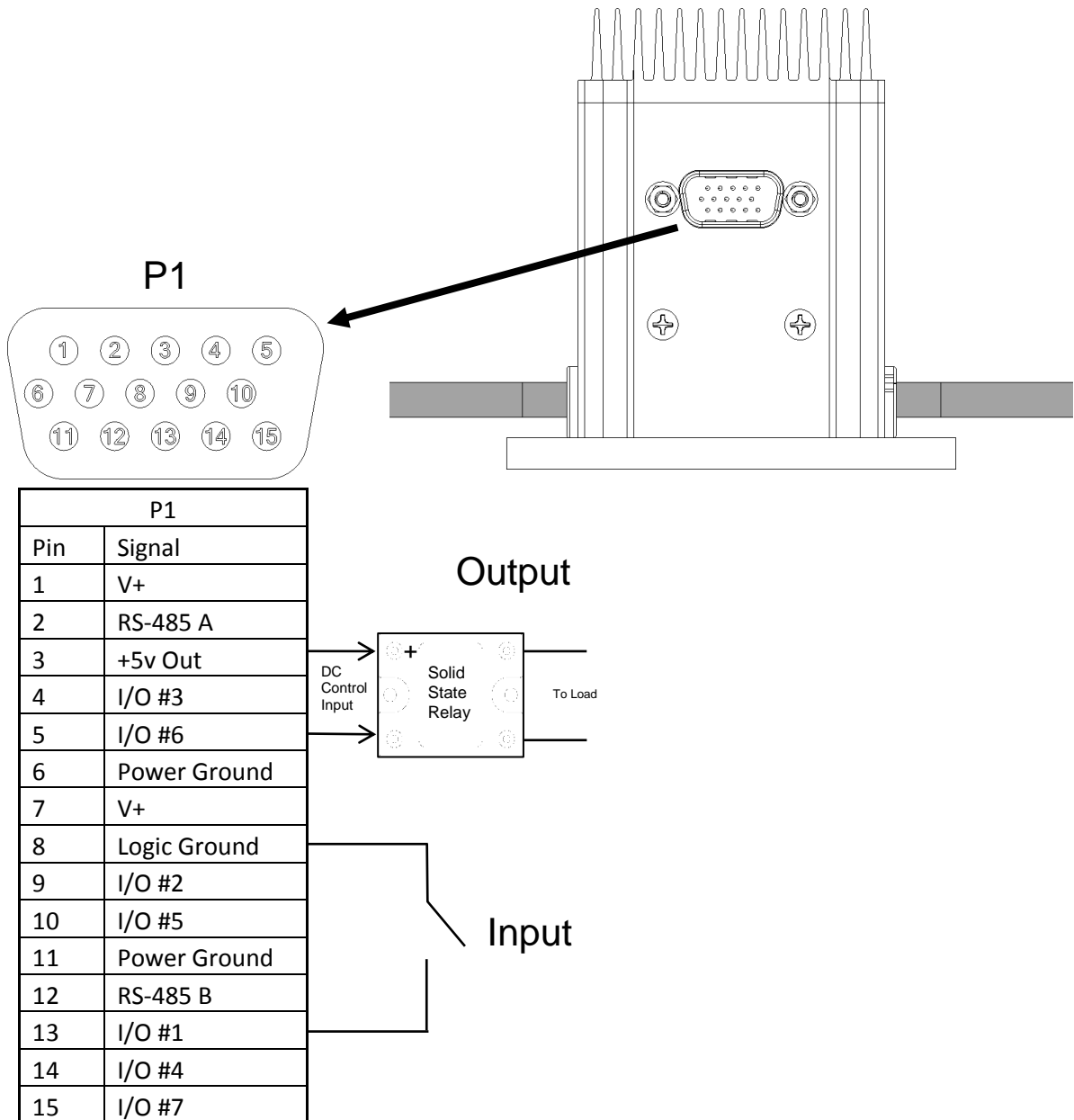

Mechanical Dimensions

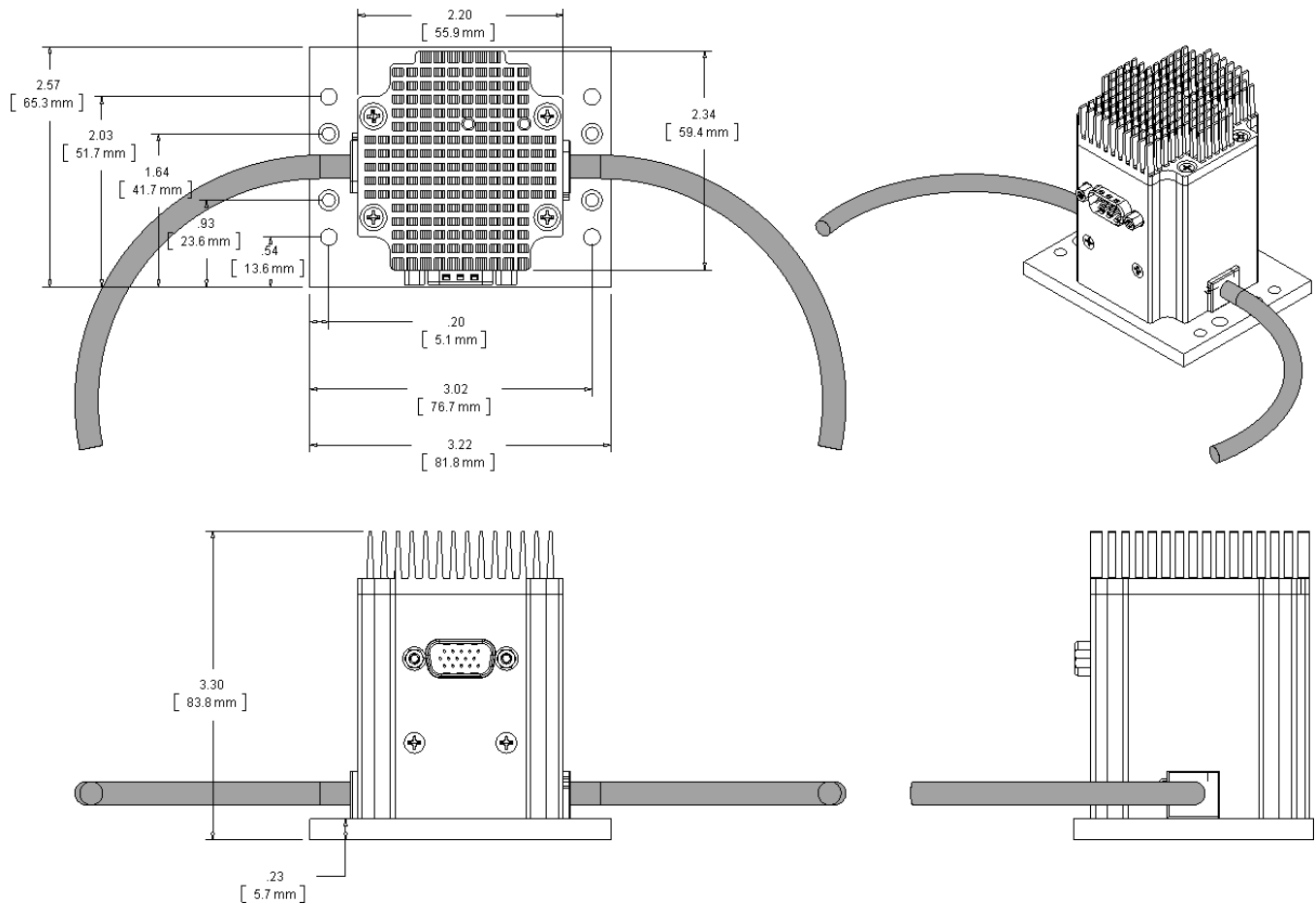

Note: See our website for 2D drawings and 3D models. Specifications subject to change without notice. See www.QuickSilverControls.com for current information.

Recommended Components

SilverNugget N2-MX Start-Up Materials

For first time users, QCI recommends purchasing the following items to aid with use of the N2-MX controller:

- 4' DB15HD Motor Interface Cable (QCI-C-D15P-D15S-04)
- Basic Breakout Module (QCI-BO-B4)
- USB to RS485 converter (QCI-USB-RS485)

Optionally:

- 240W, +48V Power Supply (SP-240-48)
- Power Supply Cord w/ Flying Leads (QCI-C-ACP-FLY-6)

Software is free and available from our website.

Typical System Setup

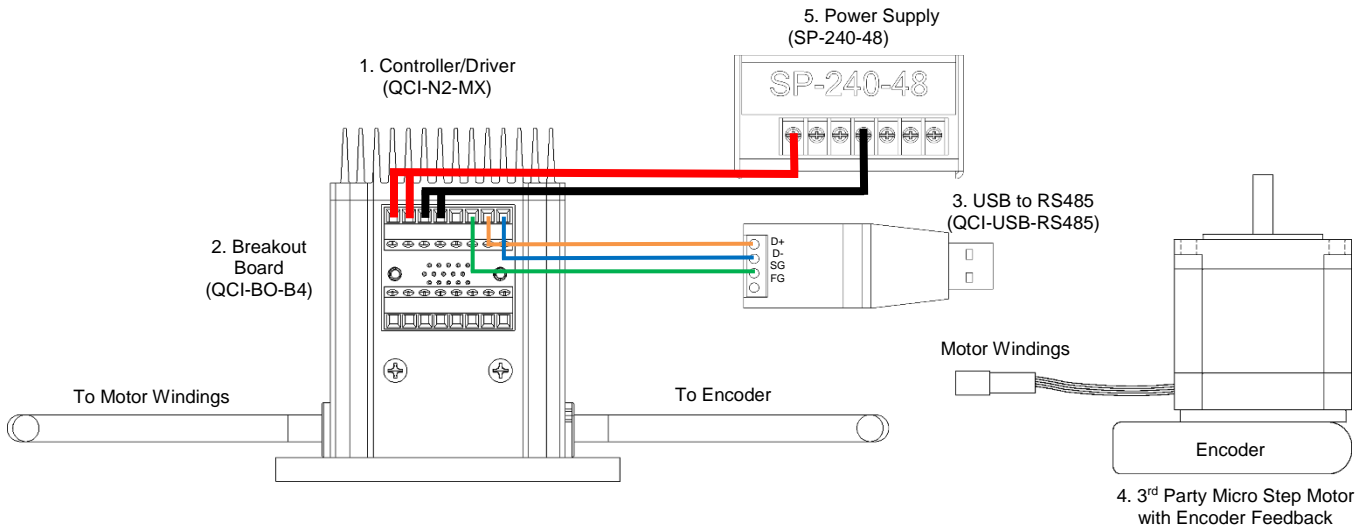

1. Controller/Driver

The standard controller/driver is QCI-N2-MX.

2. Basic Breakout Module

QCI recommends purchasing a breakout to simplify wiring power, RS-485 communication, and 7 I/O. The QCI-BO-B4 breaks out all the signals into screw terminals blocks for wiring convenience. See QCI-TD086 for more information.

3. USB to RS485 Converter

USB-RS-485 converter provides a USB powered serial port with RS-485 signaling. See QCI-TD073 USB-RS485 Converter Setup Guide for information on network termination and shielding recommendations.

4. 3rd Party Micro Step Motor with Encoder Feedback

SilverNugget N2-MX is specifically designed to drive 100 poles, 1.8° step motors. To best utilize the capabilities of the SilverNugget, select a motor that has been optimized for micro stepping.

5. Power Supply

Power supply selection is motor dependent, but the following will work with 11, 17, 23, and 24 frame motors.

SP-240-48 (48V, 5A, 240 Watt)

6. External Regenerative Clamp (not shown)

Rapid deceleration of larger loads may require a Clamp circuit if the capacitors in the power supply output are not sufficient to hold the recovered energy. Continuous braking of a load also may require the Clamp to handle the generated power. See QCI-TD017 for more information.

QCI-CLCF-04-R2

7. SilverNugget Multi-Function Interface Cable (shown below)

The QCI-EC-SMI-nn is used to connect the SilverNugget MX to QCI-OPTMC-24 Optical I/O Module. Replace the last two digits “nn” with length of cable in feet (i.e. –10 for 10 feet). Standard lengths are 2 and 10 feet.

8. Optical I/O Module (shown below)

The QCI-OPTMC-24 converts SilverNugget MX’s SMI Port LVTTTL I/O to optically isolated 24V I/O. See QCI-TD013 for more information.

Typical 24V I/O System Setup

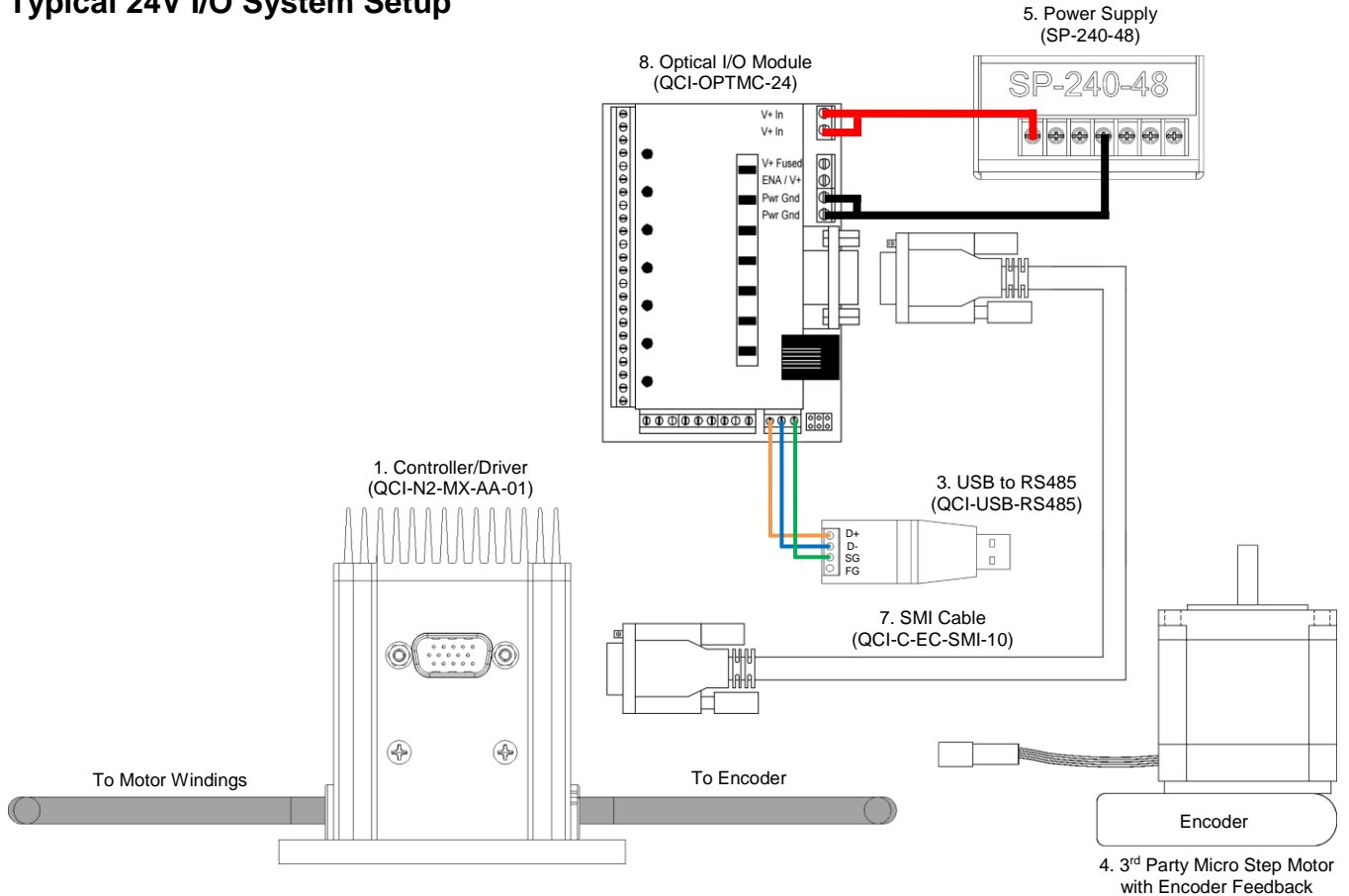

New Notable Commands and Features vs. N2-xx-01-BBnn

Analog Continuous Read Extended (ACX)

The ACX command adds additional analog channels that can be read and filtered into a dedicated register. See Command Reference Manual for more information.

Configure I/O (CIO)

For the SilverNugget N2-MX series, the CIO commands adds programmable pull-up/pull-down resistors.

Configure I/O, Immediate Mode (CII)

The CII command adds the ability to configure an I/O for input or output via serial interface at any time, even during program execution.

Calculation Extended (CLX), Calculation with Data (CLD)

Versatile calculation commands with output plus two inputs.

Increased Program Buffer Size

The SilverNugget N2-MX's program buffer is 1023 word. For comparison, the SilverNugget N2-xx-01-BBnn's program buffer is 200 words.

Multi-Threaded Capability

The SilverNugget N2-MX has the capability of running two threads in addition to a motion. If two threads are running, each thread alternates execution, causing each thread to execute at 240 microsecond ticks rather than 120 microsecond ticks when only one thread is running. See Multi-Thread Operation in User Manual for more details.

Differences Between SilverNugget N2-MX and N2-xx-01-BBnn

The SilverNugget N2-MX uses a more advanced Digital Signal Processor (DSP) for its computing engine, which allows QuickSilver to add more features. Every effort was made to make the SilverNugget N2-MX series backwards compatible with the SilverNugget N2-xx-01-BBnn series. The following is a list of differences between the SilverNugget N2-MX and N2-xx-01-BBnn series controllers. For more details on the individual products, please see their datasheets and respective SilverLode Command Reference Manuals.

Communication

Serial Interface (SIF)

SilverNugget N2-MX only supports RS-485. The RS-485 A&B lines are the same on both series (same pinout). RS-232 is no longer supported.

Protocol (PRO)

SilverNugget N2-MX, supports all three of QCI's protocols (8 Bit ASCII, 9 Bit Binary, Modbus®) with same firmware. Separate part numbers (i.e. M3, M7) are no longer needed to call out Modbus protocol.

ACK Delay (ADL)

For SilverNugget N2-MX, a negative Delay Count is interpreted as the number of 40uSec ticks to delay. Positive Delay Count is still interpreted as the number of 120uSec ticks to delay. This feature is used by ModBUS protocol to set inter frame timing.

Digital Inputs/Outputs

Background: Today's DSP technologies are moving toward smaller sizes and faster performance. As a result, lower operating voltages are necessary to reduce the power consumption of the system and generate less heat to compensate for the smaller size DSPs.

The SilverNugget N2-MX's DSP is based on a 3.3V design as opposed to the SilverNugget N2-xx-01- IX's DSP which is based on a 5.0V design. As stated earlier, every effort was made to make the N2-MX backward compatible, so that the N2-MX can accept a 0-5 Volt inputs, however due to limitation of the DSP, the output is only 0 – 3.3 Volts. Drive levels are 2mA, sinking and sourcing. All seven I/O now support analog inputs. Programmable pull-up pull-down resistors are now 2.2k, and can be programmed to be open as well.

NOTE: The use of 5V pullups on outputs is not recommended as they will most likely override the output capability of the SilverNugget N2-MX.

Data Input Range

	SilverNugget N2-xx-01-BBnn	SilverNugget N2-MX
Input Range	0 to 5.0V	0 to 3.3V
Valid HIGH	2V – 5V	2V – 5V
Valid LOW	0 – 0.8V	0 – 0.8V

I/O Output Range

	SilverNugget N2-xx-01-BBnn	SilverNugget N2-MX
Output Range	0 to 5.0V	0 to 3.3V

Pull-Up Resistance

Input	SilverNugget N2-xx-01-BBnn	SilverNugget N2-MX
1	4.7K	~100K when pullup off, 2.2k to 0v or 3.3v programmable
2	4.7K	~100K when pullup off, 2.2k to 0v or 3.3v programmable
3	4.7K	~100K when pullup off, 2.2k to 0v or 3.3v programmable
4	~200K	~100K when pullup off, 2.2k to 0v or 3.3v programmable
5	~200K	~100K when pullup off, 2.2k to 0v or 3.3v programmable
6	~200K	~100K when pullup off, 2.2k to 0v or 3.3v programmable
7	~200K	~1MΩ pull down when pullup off, 2.2k to 0v or 3.3v programmable

Sinking or Sourcing Limits

Output	SilverNugget N2-xx-01-BBnn	SilverNugget N2-MX
1	5mA	2mA
2	5mA	2mA
3	5mA	2mA
4	5mA	2mA
5	5mA	2mA
6	5mA	2mA
7	5mA	2mA

Analog Inputs

	SilverNugget N2-xx-01-BBnn	SilverNugget N2-MX
Total Available Analog Inputs	4	7
Range	0 to 5.0V	0 to 3.3V
Number of Bits	10	12
Resolution	4.88mV	0.805mV
Data range when read into a register	0-32767	0-32760
0 to +10V input	N/A	Available on I/O #7, separate analog channel scaled to 0-10v

Primary Encoder Support

Encoder Index

SilverNugget N2-MX supports standard, single index pulse encoders as well as QCI's special 49 index encoder. This is soft configured at initialization time. The SilverNugget N2-xx-01-BBnn required separate firmware for the 49 index encoders.

Encoder Resolution Reduction

SilverNugget N2-MX supports a user configurable encoder resolution reduction via our QuickControl software through the Initialization Wizard. Separate part numbers (i.e. F2, F4) are no longer needed to call out an encoder resolution reduction.

Secondary Encoder Support

Select External Encoder (SEE)

Index Source

- 0 = I/O #6
- 1 = I/O #3 (not supported in N2-MX)
- 2 = Enable Internal Encoder onto I/O# 4, 5, and 6.

Encoder Style

- 0 = A/B Quad on I/O# 4 & 5
- 1 = ~~Step Up/Down on I/O# 4 & 5~~ (not supported in N2-MX)
- 2 = Step & Direction on I/O# 4 & 5
- 3 = ~~Step & Direction on I/O# 2 & 3~~ (not supported in N2-MX)
- 7 = Configure I/O# 4, 5, and 6 back into I/O.

Select Encoder Filter (SEF)

For SilverNugget N2-MX, Select Encoder Filter:

- 0 = 100ns filter
- 1 = 300ns filter (was 600nS for N2-xx-01-BBnn)

Enable Encoder Monitor (EEM)

EEM command outputs a buffered copy of the raw encoder signals onto I/O# 1, 2, and 3. For SilverNugget N2-MX, if the EEM command is enabled **and** the SEE command is enabled to output the internal encoder on I/O# 4, 5 and 6, then the encoder signals to I/O # 1, 2, and 3 are **inverted** so as to provide differential encoder output signals.

Motor Driver

The SilverNugget N2-MX has a continuous per phase rating of 5 Amps. The SilverNugget N2-xx-01-BBnn's continuous per phase rating is 3.5 Amps. (Driver is rated to 6A, the connector is only rated to 5A). Minimum input voltage for full current is now 12.5v rather than 12v.

Commands No Longer Supported

The following are commands not supported by SilverNugget N2-MX as the modulo encoder output function is not available in the N2-MX. The new ability to use ratios or high accuracy decimal scaling for the encoder following modes has made the hardware divisors no longer useful.

Modulo Clear (MDC)

Modulo Set (MDS)

Modulo Trigger (MDT)

Part Numbers

silverNugget N2-MX Controller/Driver				
Driver	Controller	Motor Connector	Encoder Connector	Cable Length (ft)
QCI-N2	MX- Standard <ul style="list-style-type: none"> • 8-bit ASCII, Modbus® RTU, DMX512, 9-bit • 12.5v to 48v • RS-485 – multiple protocols • 7 LVTTTL I/O <ul style="list-style-type: none"> ○ All configurable as 0-3.3v analog inputs • 1 Output supports PWM Out <ul style="list-style-type: none"> ○ Use QCI-BO-B1A to amplify to 0-5v • 1 Input supports PWM In • SilverLode Multi-Function Interface (SMI) Port <ul style="list-style-type: none"> ○ DB15 High Density (Pin) 	A – Flying Lead B – TE or Molex Compatible Connector	A – Flying Lead B – Molex Compatible Connector	nn – length in feet
To create a part number, choose one from each column above.				
QCI-N2	MX	B	B	01
This selection creates the part number: QCI-N2-MX-BB01				

Contact Information

QuickSilver Controls, Inc.
 990 N Amelia Ave
 San Dimas, CA 91773
 +1 (909) 599-6291 or (888) 660-3801
 +1 (909) 599-6289 FAX
www.QuickSilverControls.com